



SSA... without auxiliary switch



SSA...1 with auxiliary switch



Electrical actuators

for radiator valves, MiniCombiValves (MCV) and small valves

SSA31...

SSA81...

SSA61...

- **SSA31...** operating voltage AC 230 V 3-position control signal
- **SSA81...** operating voltage AC 24 V 3-position control signal
- **SSA61...** operating voltage AC / DC 24 V DC 0...10 V control signal
- **Nominal force 100 N**
- **Automatic identification of valve stroke**
- **Direct mounting with coupling nut, no tools required**
- **Basic types complete with plug-in connecting cable, length 1.5 m**
- **Optional cable types**
 - Cable length 1.5 m, 2.5 m and 4.5 m
 - Halogen-free cables
 - 2.5 m cables with Batigyr connector
- **Manual override and position indication**
- **Parallel connection of multiple actuators possible**
- **Auxiliary switch integrated in SSA31.1 and SSA81.1 actuators**
- **Optional tamper-proof fitting to prevent dismantling**

Use

- For radiator valves, VDN..., VEN..., VUN... and MiniCombiValves, VPD..., VPE...
- For small valves, VD1...CLC
- For radiator valves with M30 x 1.5 screwed fitting, nominal closing dimension 11.6 mm and a 2.5 mm nominal stroke (without adapter). Also for use with third-party valves in conjunction with AV-type adapter
- For modulating or 3-position control in heating systems, chilled ceilings and terminal units.

Type summary

Type reference	Operating voltage	Run time at 50 Hz	Control signal	Connecting cable	Auxiliary switch
SSA31	AC 230 V	150 s	3-position	1.5 m	
SSA31/00 ¹⁾				no cable	
SSA31.1				1.5 m	Yes
SSA81	AC 24 V			1.5 m	
SSA81/00 ¹⁾				no cable	
SSA81.1				1.5 m	Yes
SSA61	AC / DC 24 V	34 s	DC 0...10 V	1.5 m	
SSA61/00 ¹⁾				no cable	

¹⁾ For available cable lengths or terminal block connectors refer to "Accessories", page 3

Accessories

Type reference	Description	Operating voltage	Control signal
ASY3L15	Connecting cable 1.5 m	AC 230 V	3-position
ASY3L25	Connecting cable 2.5 m		
ASY3L45	Connecting cable 4.5 m		
ASY8L15	Connecting cable 1.5 m	AC 24 V	
ASY8L25	Connecting cable 2.5 m		
ASY8L25B	Connecting cable 2.5 m with Batigyr connector		
ASY8L45	Connecting cable 4.5 m		
ASY8L45HF	Connecting cable 4.5 m, halogen-free, VDE 0207-24	AC / DC 24 V	DC 0...10 V
ASY6L15	Connecting cable 1.5 m		
ASY6L25	Connecting cable 2.5 m		
ASY6L45	Connecting cable 4.5 m		
ASY6L45HF	Connecting cable 4.5 m, halogen-free, VDE 0207-24		
ASY98	Retaining screw for terminal block connectors		
ASY99	Terminal block connector for 3-position actuators SSA81.../00		
ASY100	Terminal block connector for DC 0...10 V modulating actuators SSA61/00		
AL40	Tamper-proof fitting to prevent dismantling of actuators		

Adapter type	for third-party valves	Adapter type	for third-party valves
AV51	Beulco old (M30x1.0)	AV56	Giacomini
AV52	Comap	AV57	Herz
AV53	Danfoss RA-N (RA2000)	AV58	Oventrop old (M30x1.0), till 2002
AV54	Danfoss RAVL	AV59	Vaillant
AV55	Danfoss RAV	AV60	TA, till 2002 ¹⁾
		AV61	Markaryd (MMA)

¹⁾ No adapter required for type TBV-C

Ordering

Example

When ordering, please give quantity, product name and type reference.

- 2 actuators SSA81/00 without cable and
- 2 connecting cables ASY8L45

Delivery

Actuators, valves and accessories are packed separately.

Equipment combinations

Type reference	Valve type	k_{vs} [m ³ /h]	\dot{V} [l/h]	PN class	Data sheet
VDN..., VEN..., VUN...	Radiator valves	0.09...1.41		PN 10	N2105, N2106
VPD..., VPE...	MCV radiator valves		25...483		N2185
VD1...CLC	Small valves	0.25...2.60			N2103
For other radiator valves with type AV... adapters refer to "Type summary / accessories"					
Radiator valves (M30 x 1.5) from other manufacturers, without adapter:					
<ul style="list-style-type: none"> • Heimeier • Crane D981... • TA-Typ TBV-C • Oventrop M30 x 1.5 (from 2001) • MNG • Junkers • Honeywell-Braukmann • Cazzaniga • Beulco (new) 					

k_{vs} = nominal flow rate of cold water (5...30 °C) through the fully open valve (H_{100}) at a differential pressure of 100 kPa (1 bar)

\dot{V} = Nominal volume flow at 0.5 mm stroke

Valves from other manufacturers

To ensure trouble-free operation of third-party valves with the SSA... actuator, the valves must satisfy the following requirements:

- Threaded connections with coupling nut M30 x 1.5
- Nominal force $F \leq 100 \text{ N}$
- Dimension x $x > 9.0 \text{ mm}$
- Dimension y $y \leq 14.5 \text{ mm}$

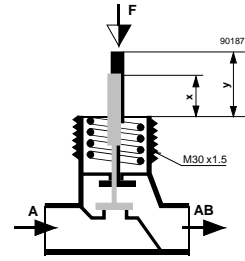

Function / mechanical design

When the actuator is driven by DC 0...10 V control voltage or by a 3-position signal, it produces a stroke which is transmitted to the valve stem.

The description of operation in this document applies to the valve versions which are fully open when de-energized (NO).

3-position control signal SSA31... / SSA81...

- Voltage at Y1: Stem retracts Valve opens
- Voltage at Y2: Stem extends Valve closes
- No voltage at Y1 and Y2: Actuator maintains its current position

DC 0...10 V control signal SSA61...

- The valve opens / closes in proportion to the control signal at Y.
- At DC 0 V, the valve is fully closed (A → AB), stem extended
- When power supply is removed, the actuator maintains its current position.

Features and advantages

- Plastic housing
- Locking-proof, maintenance-free gear train
- Manual override with hexagonal socket wrench 3 mm
- Reduced power consumption in the holding positions
- Load-dependent switch-off in the event of overload and in stroke end positions
- Parallel operation of 6 SSA31..., 24 SSA81... and 10 SSA61... possible, provided the controllers' output is sufficient
- Terminal block connectors for customer made cables available (only for use with AC 24 V and AC / DC 24 V actuators)
- Connecting cables with AC 24 V and AC 230 V connectors cannot be mixed up
- Halogen-free cables available

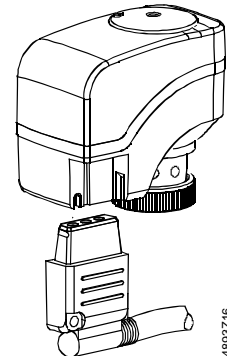

Accessories

Adapter type AV... for third-party valves

Adapter types AV51 to AV61 are available for mounting the SSA... actuators on third-party radiator valves as shown under "Type summary/accessories", page 2.

Tamper-proof fitting AL40

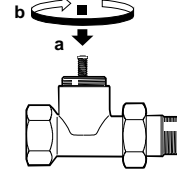
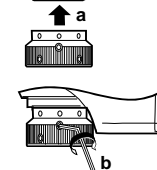
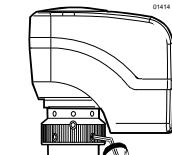
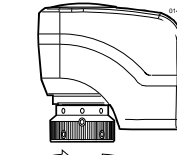
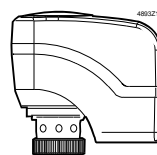
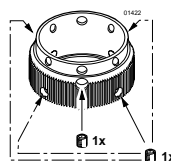

Retaining screw
ASY98



Type ASY98 to secure the cable connector

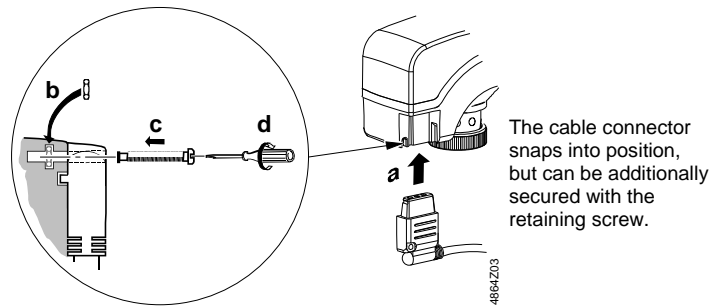

Terminal block connectors
ASY99
ASY100

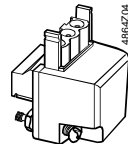

For special cable lengths of the AC / DC 24 V actuators.

- Type ASY99 for 3-position actuators SSA81.../00
- Type ASY100 for DC 0...10 V modulating actuators SSA61/00

The terminal block connectors are supplied complete with mounting instructions (74 319 0385 0).

Notes

Engineering

The actuators must be electrically connected in accordance with local regulations (refer to "Connection diagrams", page 7).



Regulations and requirements to ensure the safety of people and property must be observed at all times!

The permissible temperatures (refer to "Technical data", page 6) must be observed. The connecting cable of the actuator may come into contact with the hot valve body, provided the temperature of the valve body does not exceed 80 °C. Actuator types SSA 31.1 and SSA81.1 have a built-in auxiliary switch. The switch cannot be fitted in other actuators later.

Mounting

Mounting instructions (Ref. 74 319 0497 0) are enclosed in the product packaging. The actuator and valve are assembled with the coupling nut; no tools or adjustments are required.



The actuator must be fitted in position 1 with the power disconnected (refer also to "Manual override", page 5):

- Position the actuator and tighten the coupling nut manually
- Do not use any tools such as wrenches
- Avoid lateral pressure or (cable) tension on the mounted actuator!

In the case of actuators without a connecting cable (SSA.../00), the separately ordered terminal block connector and connecting cable must be fitted.

Orientation

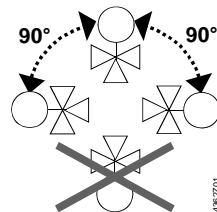

Commissioning

When commissioning, check the wiring and the functioning of the actuator and auxiliary switch, if fitted.

- Actuator stem extends (from position 1 to 0): Valve closes
- Actuator stem retracts (from position 0 to 1): Valve opens

Self-calibration



During commissioning and whenever the operating voltage is switched on, the SSA61... runs a self-calibration routine. (Valve stroke 0 → Max. stroke → Setpoint).
Never intervene manually in this process.

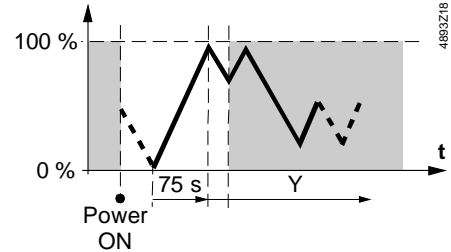

Note: Correct calibration is only possible

- with valve
- stroke > 1.5 mm

The second or third attempt at calibration occurs automatically after an 8-minute delay.

After three failed calibration attempts the actuator stem remains in the extended position and the radiator valves are closed.

For valves with strokes < 1.5 mm, the actuator/valve combination locks after three failed calibration attempts.

The new Siemens type VDN..., VEN... and VUN... radiator valves have in all 1.5 mm stroke.

Operation

A 3 mm hexagonal socket wrench can be used to move the actuator to any position between 0 and 1. However, if a control signal from the controller is present, then this takes priority in determining the position.

Note

To retain the manually set position, unplug the connecting cable or switch off the operating voltage and the control signal.

Manual override

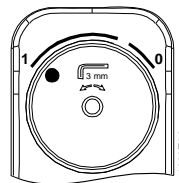
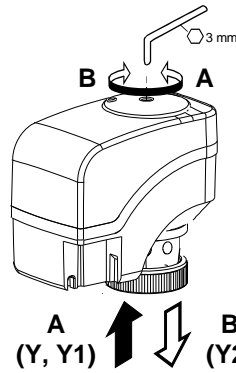

Position indicator in position 1: Valve open

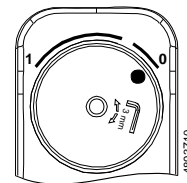

Position indicator in position 0: Valve closed

Maintenance

The actuators are maintenance-free.

When carrying out service work on the plant, following must be noted:

- Turn power off (e.g. remove the plug)
- If necessary, disconnect electrical connections from the terminals
- The actuator must be commissioned only with a correctly mounted valve in place!



Repair

SSA... actuators cannot be repaired; the complete unit must be replaced.

Disposal



The device must not be disposed of together with domestic waste. This applies in particular to the PCB.

Legislation may demand special handling of certain components, or it may be sensible from an ecological point of view.

Current local legislation must be observed.

Warranty

The technical data given for these applications is valid only when the actuators are used with the Siemens valves listed under "Equipment combinations", page 2.

The use of the SSA... actuators in conjunction with third-party valves invalidates any warranty offered by Siemens Building Technologies / HVAC Products.

Technical data

		SSA31...	SSA81...	SSA61...	
Power supply	Operating voltage	AC 230 V	AC 24 V	AC 24 V or DC 24 V	
	Voltage tolerance	± 15%	± 20%	± 20% ± 25%	
	Frequency	50 / 60 Hz			
	Max. power consumption	6 VA	0.8 VA	2.5 VA	
	⚠ Fuse for incoming cable	2 A, quickblow			
Control	Control signal	3-position		DC 0...10 V	
	Input impedance for DC 0...10 V			> 100 kOhm	
	Parallel operation (number of actuators) ¹⁾	max. 6	max. 24	max. 10	
Functional data	Run time for 2.5 mm stroke at 50 Hz	150 s		34 s	
	Nominal stroke	2.5 mm (max. 5.5 mm)			
	Nominal force	100 N			
	Perm. temperature of medium in the connected valve	1...110 °C (1...90 °C for MCV-radiator valves)			
	Electrical connections	Connecting cable of basic types	1.5 m 3-core to EN 60320 / IEC 60227		
Norms and standards	Meets requirements for CE marking: EMC directive	2004/108/EC			
		Immunity	EN 61000-6-2	Industrial ²⁾	
		Emission	EN 61000-6-3	Residential	
	Low voltage directive	2006/95/EC			
		Electrical safety	EN 60730-1		
		Protection class to EN 60730	II	III	
		Contamination level	EN 60730, Class 2		
	Housing protection	IP40 to EN 60529			
	Upright to horizontal	IP40 to EN 60529			
	Environmental compatibility	ISO 14001 (Environment) ISO 9001 (Quality) SN 36350 (Environmentally compatible products) RL 2002/95/EG (RoHS)			
Dimensions / weight	Dimensions	refer to "Dimensions", page 8			
	Coupling thread to valve	Coupling nut M30 x 1.5			
	Weight with / without auxiliary switch	0.4 kg / 0.35 kg			
Housing colors	Base	RAL 7035 light gray			
	Cover	RAL 9003 signal white			
Auxiliary switch	Mounted in SSA31.1 and SSA81.1 Switching point adjustable Factory setting 50% Switching capacity	1 change-over switch 0...100 % max. AC 250 V, 1 A (0.5 A)			

¹⁾ Provided the controller output is sufficient

²⁾ 160 VA transformer (e.g. Siemens 4AM3842-4TN00-0EA0) for AC 24 V actuators

General ambient conditions

	Operation	Transport	Storage
	EN 721-3-3	EN 721-3-2	EN 721-3-1
Environmental conditions	Class 3K3	Class 2K3	Class 1K3
Temperature	+1...+50 °C	-25...+70 °C	-5...+50 °C
Humidity	5...85 % r.h.	< 95 % r.h.	5...95 % r.h.

Connecting cable

SSA31...

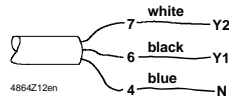

Control signal CLOSE (AC 230 V)
Control signal OPEN (AC 230 V)
Neutral

SSA81...

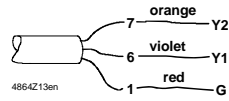

Control signal CLOSE (AC 24 V)
Control signal OPEN (AC 24 V)
System potential (AC 24 V)

SSA61...

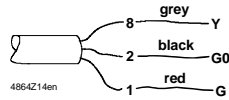

Control signal DC 0...10 V (AC 24 V)
System neutral (- DC 24 V)
System potential AC 24 V (+ DC 24 V)

Connection terminals

ASY99
for SSA81...

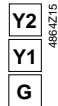

Control signal CLOSE
Control signal OPEN
System potential AC 24 V

ASY100
for SSA61

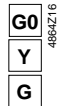

System neutral
Control signal DC 0...10 V
System potential AC / DC 24 V

Terminals for auxiliary switches

SSA31.1, SSA81.1

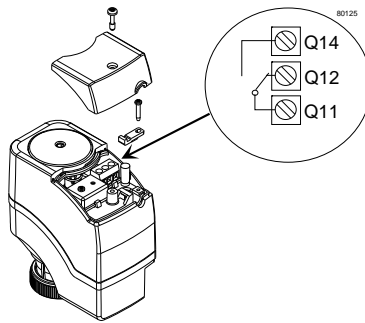

Factory setting:

0...50 % Q11 → Q12
50 %...1 Q11 → Q14

The switching point can be adjusted by turning the switching cam with a screwdriver (see Mounting Instructions).

Connection diagrams

SSA31...

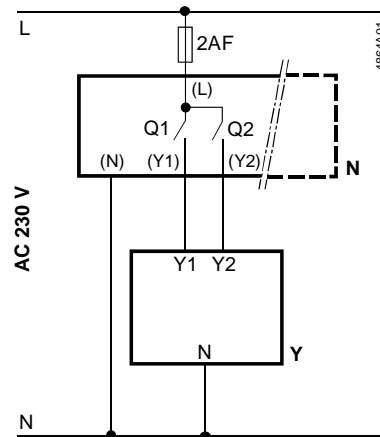

N Controller
Y Actuator
L System potential AC 230 V
N System neutral
Y1, Y2 Control signal OPEN, CLOSE
Q1, Q2 Controller contacts

SSA81...

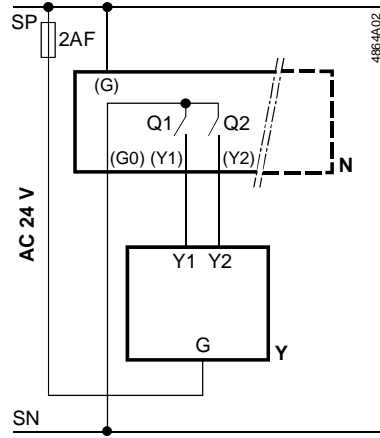

- N Controller
- Y Actuator
- SP, G System potential AC 24 V
- SN, G0 System neutral
- Y1, Y2 Control signal OPEN, CLOSE
- Q1, Q2 Controller contacts

SSA61...

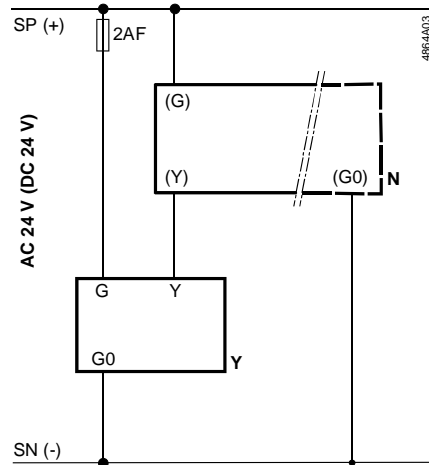

- N Controller
- Y Actuator
- SP, G System potential AC 24 V
- SN, G0 System neutral
- Y Control signal

Dimensions

Dimensions in mm

Actuator without auxiliary switch

SSA31...
SSA81...
SSA61...

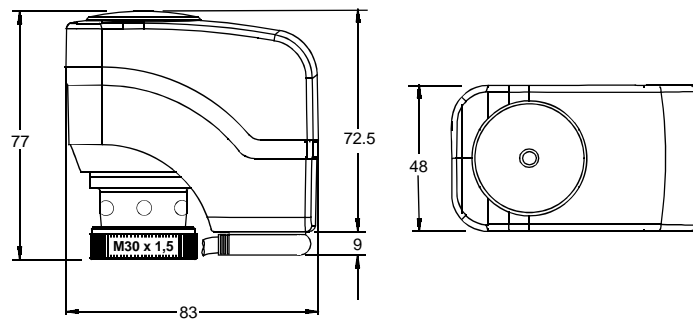

Actuator with auxiliary switch

SSA31.1...
SSA81.1...

