



Synco™ 700



Operator Unit

RMZ791

Operator unit for use with Synco™ 700 controllers, Central Control Unit and Switching and Monitoring Device

Use

The RMZ791 operator unit has been designed for use with the following controllers, Central Control Unit and Switching and Monitoring Device:

- Heating controllers RMH7..., RMK7...
- Universal controllers RMU7...
- Central Control Unit RMB795
- Switching and Monitoring Device RMS705

These types do not have an operating facility of their own.

Functions

The operator unit is used to make all controller/RMB795/RMS705 settings and to display all data required in connection with the controller/RMB795/RMS705. All entries made on the operator unit are transmitted to the controller/RMB795/RMS705 where they are handled and stored; the operator unit itself does not store any data. The information required by the user is generated by the controller/RMB795/RMS705 and delivered to the operator unit for display.

Ordering and delivery

When ordering, please give quantity, name and type reference.

The scope of delivery consists of operator unit, connecting cable and set of screws.

| Type of document | Ordering number |
|--|-----------------|
| Operating Instructions: Heating Controller RMH760, Boiler Sequence Controller RMK770 | 74 319 0346 0* |
| Operating Instructions: Universal Controllers RMU7... | 74 319 0350 0* |
| Operating Instructions: Central Control Unit RMB795 | 74 319 0462 0* |
| Operating Instructions: Switching and Monitoring Device RMS705 | 74 319 0503 0* |
| Mounting Instructions: RMZ791 | 74 319 0339 0 |
| Product range description: Synco™ 700 | CE1S3110en |
| Environmental Product Declaration: RMZ791 | CE1E3110en04 |

* In German, English, French and Dutch

Mechanical design

Basic design

The operator unit has been designed for detached use. It consists of mounting plate, housing with LCD, operating elements on the front and 10-polar terminal strip. The electrical connection to the controller/RMB795/RMS705 is made via the connecting cable supplied with the controller/RMB795/RMS705. The operator unit also receives its power via the connecting cable. The connecting cable exits the unit at the bottom or rear.

Mounting choices

The operator unit has been designed for 2 methods of mounting:

- On a front, e.g. on the control panel door
- In a panel cutout; to fix the mounting plate, 4 knockout tongues are provided

If the operator unit is fitted in a panel cutout, the controller/RMB795/RMS705 can be attached directly to the rear with the help of a top hat rail. To ensure correct positioning of the top hat rail at the rear, the mounting plant carries a marking.

Operating elements

On the software side, all settings and readout values are arranged as data points of a menu tree. Using the operating elements, every data point can be selected, displayed or set. All menus appear on the LCD as plain text.

The controller/RMB795/RMS705 has several languages preprogrammed; when commissioning the controller/RMB795/RMS705, the required language is to be activated. The controller/RMB795/RMS705 is supplied complete with Operating instructions; they contain all languages stored in the controller/RMB795/RMS705.

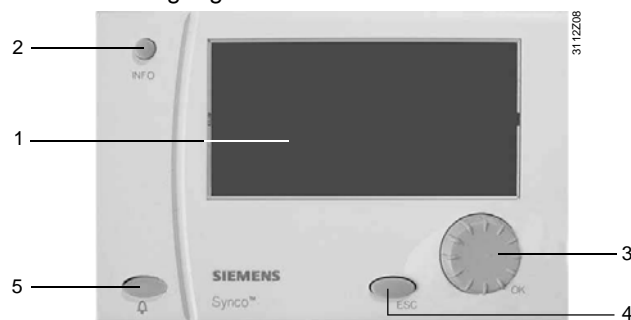

- 1 Display
- 2 INFO button
- 3 Select-and-press knob OK
- 4 ESC button
- 5 Fault button with integrated LED

When an operating element is activated, the backlit display will automatically be switched on. If not operated for 30 minutes, the backlight will switch itself off and the start display appears.

Display examples

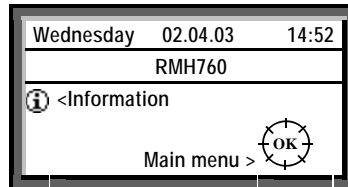

Start display

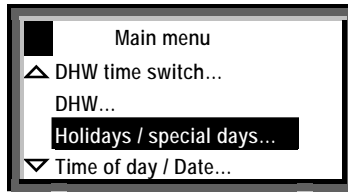

Main menu, selection of a setting parameter

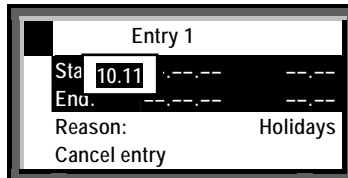

Pop-up window, setting a numerical value

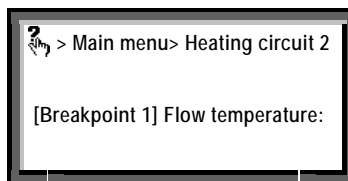

Help picture with explanations on the selected data point

Accessories

The following accessories are included in the scope of delivery:

- 1 connecting cable of 3 m
- 1 screw set (4xST 2.9x13 mm)

Mounting notes

Mounting methods

Suitable mounting location is a front (control panel front or control desk).

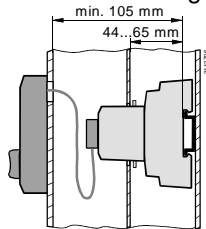

The operator unit is fitted to the control panel front; the controller/RMB795/RMS705 is mounted inside the control panel.

For the introduction of the connecting cable, the control panel front must have an opening of about 30 mm diameter.

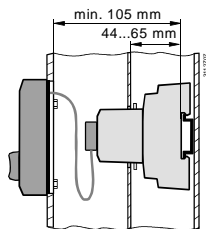

The operator unit is fitted in a control panel cutout (for dimensions of cutout, refer to "Dimensions").

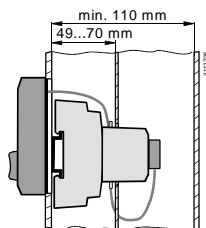

The operator unit is fitted in a control panel cutout; the controller/RMB795/RMS705 is fitted to the rear of the control panel door.

Fitting

Before securing the mounting plate to the front, connect the terminal strip of the connecting cable to the terminal strip of the mounting plate. After mounting on the front, the housing can be snapped onto the mounting plate.

The operator unit is supplied complete with Mounting Instructions.

Commissioning notes

The operator unit requires no commissioning. It is ready to operate as soon as the controller/RMB795/RMS705 receives power.

Technical data

| | |
|--|---|
| Degrees of protection | |
| Housing | IP 20 to EN 60 529 |
| Safety class | III to EN 60 730 |
| EMC directive | 2004/108/EC |
| For use in industrial and domestic environments | |
| Immunity | EN 60730-1 |
| Emissions | EN 60730-1 |
| Environmental compatibility | |
| The product environmental declaration CE1E3110en04 contains data on environmentally compatible product design and assessments (RoHS compliance, materials composition, packaging, environmental benefit, disposal) | ISO 14001 (Environment) ISO 9001 (Quality) SN 36350 (Environmentally compatible products) RL 2002/95/EG (RoHS) |
| Display | |
| Active field | 82x42 mm |
| Resolution | 128x64 pixels |
| Housing | |
| Color | RAL 7035 (light-gray) |
| Material | Polycarbonate |
| Connecting cable | |
| Mechanical design | 10-core with two 10-polar terminal strips |
| Length | 3 m |
| Weight incl. connecting cable and packaging | 0.345 kg |

Dimensions

Operating unit

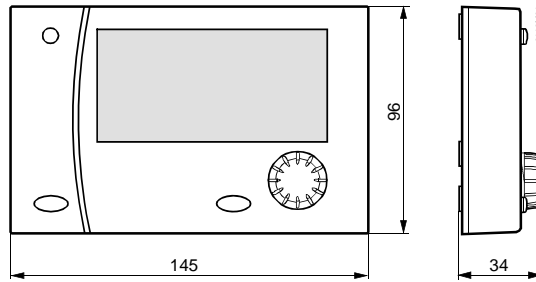

Drilling template for front mounting

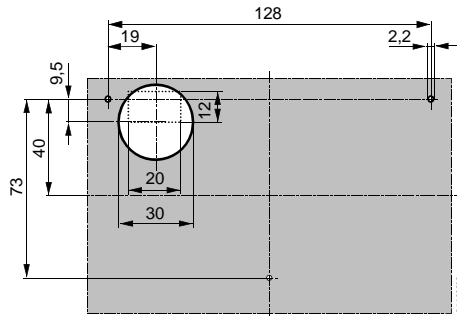

Control panel cutout (with controller/RMB795/RMS705 mounted at the rear)

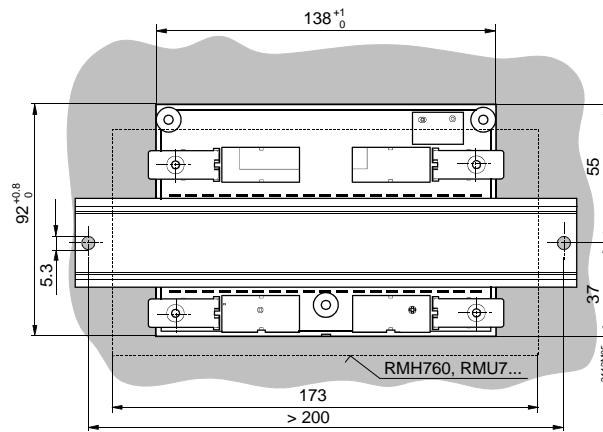

Dimensions in mm

